

## EX-EVSG 25

EX stop end, polyamide, M25

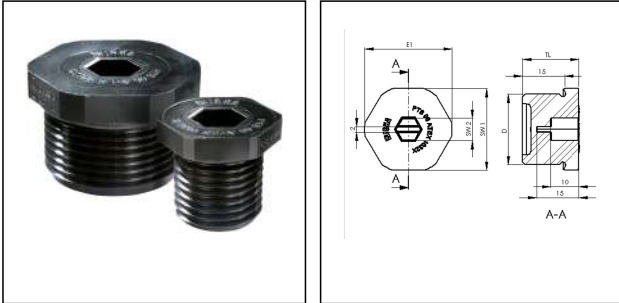

Products may differ in size, colour and appearance to those shown. If you require further information or customisation, please contact us directly.



<b>Material</b>	Polyamide
<b>Material sealing gasket</b>	EPDM
<b>Temp. range min</b>	-40 °C
<b>Temp. range max</b>	75 °C
<b>Protection class</b>	IP66 / IP68 (5 bar 30 min)
<b>Type of protection</b>	Ex eb, Ex tb
<b>Ex-Certificate</b>	ATEX, IECEx
<b>Product Color</b>	RAL 9005
<b>Thread type</b>	M
<b>Ø Connection thread D</b>	25
<b>Lead</b>	1,5
<b>Length screw-in thread L</b>	15 mm
<b>Key width SW1</b>	29 mm
<b>Key width SW2</b>	8 mm
<b>Collar diameter E1</b>	31 mm
<b>Collar diameter E2</b>	9 mm
<b>Total length TL</b>	20 mm
<b>Order no. RAL 9005</b>	10065303
<b>Type</b>	EX-EVSG 25
<b>Packing unit</b>	100
<b>ETIM-Classification</b>	EC000032

### Recommended accessories

Your Contact:

WISKA Hoppmann GmbH  
Kisdorfer Weg 28 · 24568 Kaltenkirchen · Germany  
☎ +49-4191-508-0 · 📠 +49-4191-508-209  
contact@wiska.de · www.wiska.com

01.04.2020

Your Contact:

**WISKA Hoppmann GmbH**

Kisdorfer Weg 28 · 24568 Kaltenkirchen · Germany

☎ +49-4191-508-0 · 📠 +49-4191-508-209

contact@wiska.de · www.wiska.com

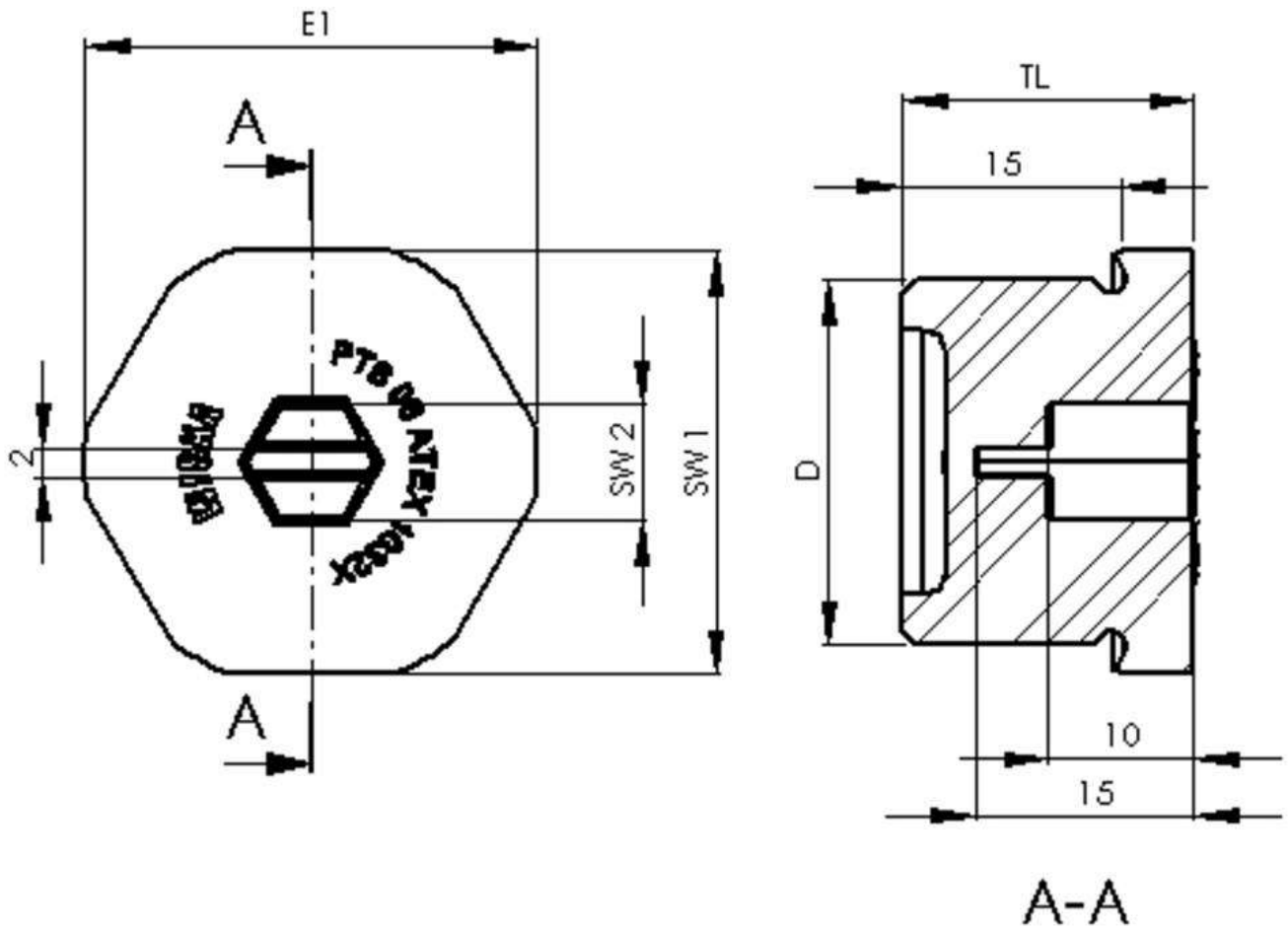

Your Contact:

**WISKA Hoppmann GmbH**

Kisdorfer Weg 28 · 24568 Kaltenkirchen · Germany

☎ +49-4191-508-0 · 📠 +49-4191-508-209

contact@wiska.de · www.wiska.com