

Plug PowerTOP® - Part no. 3809

- screw terminals
- highly heat resistant contact carrier
- nickel plated contacts
- cable gland and external cable grip

| | |
|-----------------------|---|
| Protection type | IP 67 |
| Ampere | 16 A |
| Poles | 4 p |
| Voltage | 400 V |
| Hertz | 50-60 Hz |
| Earth position | 6 h |
| Contact | nickel plated contacts, highly heat resistant contact carrier |
| Connection technology | Screw terminals |

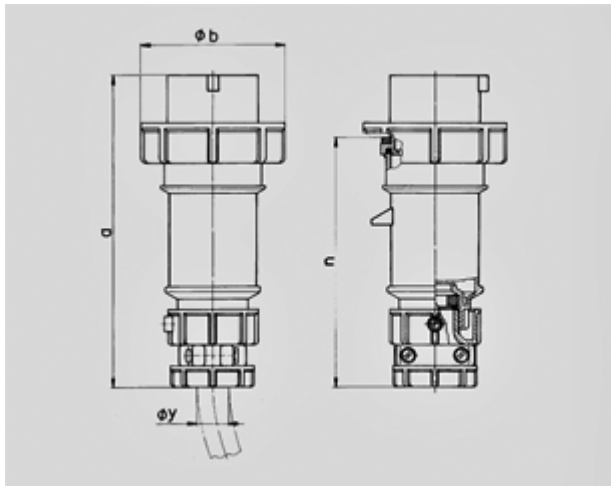

| Drawing | Amp. | 16 | | | 32 | | |
|--------------------------------------|-------|------|------|------|------|------|------|
| | | 3 | 4 | 5 | 3 | 4 | 5 |
| 2 MB 171 | Poles | | | | | | |
| Dim. in mm | a | 162 | 172 | 186 | 199 | 199 | 213 |
| | b | 71 | 79 | 89 | 95 | 95 | 102 |
| | n | 129 | 139 | 152 | 157 | 157 | 172 |
| | y | 19 | 19 | 22 | 24,5 | 24,5 | 28,5 |
| Terminal for cond. cross | | 1 | 1 | 1 | 2,5 | 2,5 | 2,5 |
| section (mm ²) min.-max. | | -2,5 | -2,5 | -2,5 | -6 | -6 | -6 |