

Connector AM-TOP® - Part no. 550

- screw terminals
- single part body
- cable gland and sealing
- strain relief and protection against kinking

Protection type IP 67
 Ampere 16 A
 Poles 5 p
 Voltage 400 V
 Hertz 50-60 Hz
 Earth position 6 h
 Contact standard
 Connection technology Screw terminals

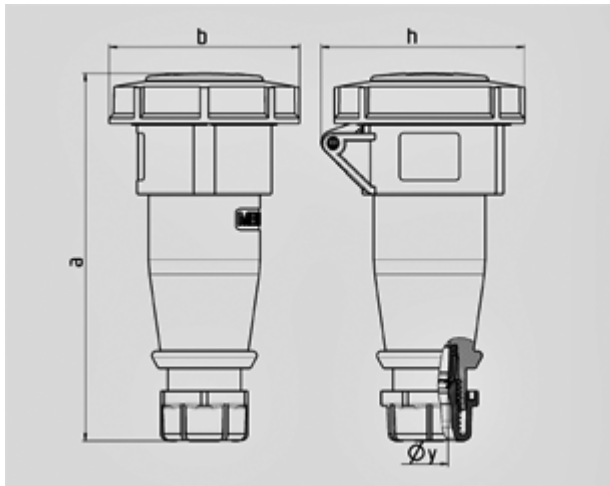

Drawing	Amp.	16			32		
		Poles			3	4	5
3 MB 62							
Dim. in mm	a	146	166	172	212	212	213
	b	72	79	89	96	96	102
	h	80	88	95	98	98	105
	y	14,5	16	16	22	22	22
Terminal for cond. cross		1	1	1	2,5	2,5	2,5
section (mm ²) min.-max.		-2,5	-2,5	-2,5	-6	-6	-6